



Lievore,
Altherr
& Molina

KIS micro-jet nozzles linear diffusers

MADEL®

The **KIS** linear diffusers are designed to be applied in air conditioning ventilation and heating systems and at a temperature differential up to 12°C.

Micro-jet nozzles linear diffusers, giving complete flexibility of direction, suitable for wall or ceiling mounting. Diffuser constructed from aluminium and nozzles from PP.

As the result of collaboration with the **Lievore, Altherr & Molina** studio, **KIS** diffuser provides a new look for this type of diffusers, with smoother lines, reducing the visual impact within the interior architectures.

KIS

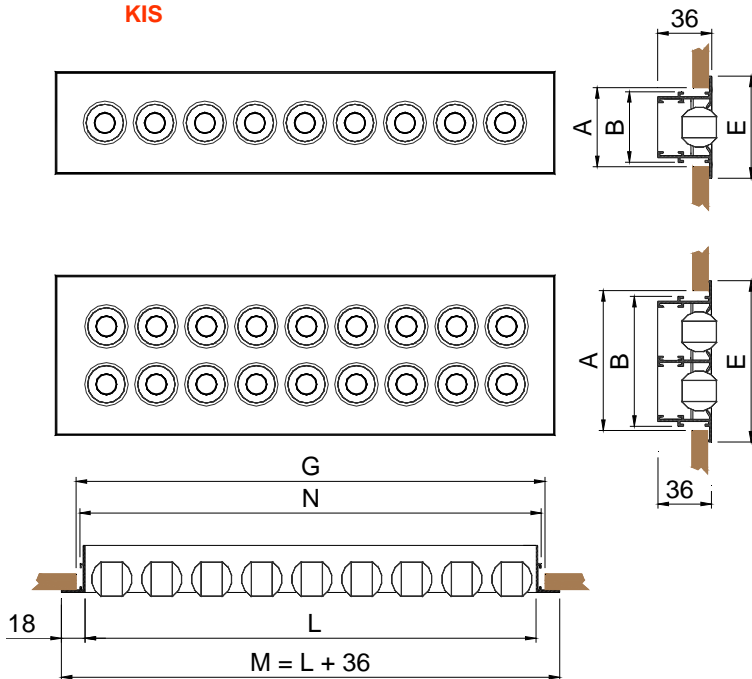

	E	A	B
KIS 1	68	55	47
KIS 2	107	95	86

L	M	N	G
500	536	507	516
1000	1036	1007	1016
1200	1236	1207	1216
1500	1536	1507	1516
2000	2036	2007	2016

CLASSIFICATION

- KIS-AR** Diffuser with end borders included. Suitable for lengths ≤ 2 m.
- ...-ARI** Diffuser with an end border on the left side, required to form lines >2 m.
- ...-ARD** Diffuser with an end border on the right side, required to form lines >2 m.
- ...-INT** Diffuser without end borders, required to form lines > 4 m.

MATERIAL

Diffuser constructed from aluminium and nozzles from PP plastic.

ACCESSORIES

- PLSD** Plenum box with lateral circular connection. It includes supports to hang from the ceiling. Made in galvanised steel.
- ...-R** Plenum box with a flow damper in the spigot.
- .../AIS/** Plenum box thermo acoustically insulated by a foam with a coefficient of thermal conductivity of 0,04 w/mk. This foam complies with the fire reaction specifications:

UNE 23-727 M2
NFP 92-501 M2
DIN 4102 M2

KIS

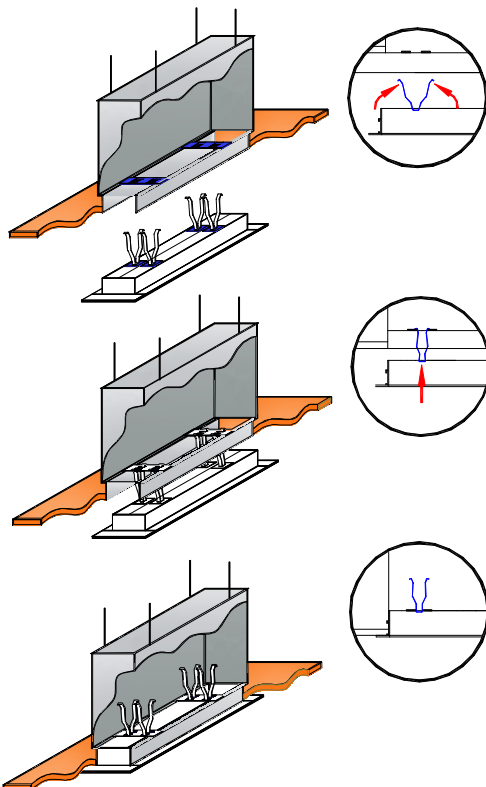
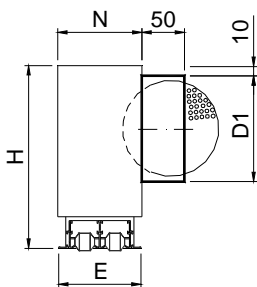
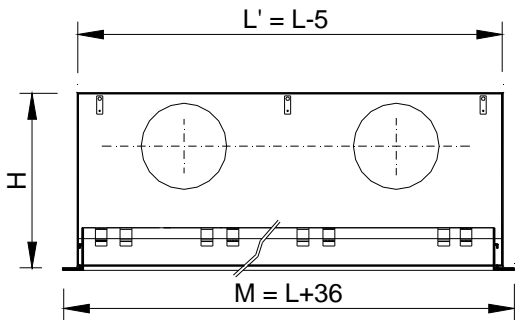

FIXING SYSTEMS

(D) Support brackets to hang KIS or KIS+PLSD from the ceiling.

(PL) Connection into PLSD+PML plenum box by clips, to hang from the ceiling. This system simplifies and facilitates the assembly and disassembling of the diffuser into the plenum box.

(PM) Set of crossbars for installation of the diffuser without plenum in false ceiling.

FINISHES

M9016 Painted in white similar to RAL 9016 with white nozzles.

R9010 Painted in white RAL 9010 with white nozzles.

M9006 Painted in grey similar to RAL 9006 with black nozzles.

R9005 Painted in black RAL 9005 with black nozzles.

RAL... Painted in other RAL colours with black or white nozzles.

SPECIFICATION TEXT

Supply and mounting of linear diffuser with micro-jet nozzles adjustable in all directions series **KIS-AR+PLSD-R M9016 1x1000** constructed from aluminium paint in white **M9016**. With lateral connection plenum box and air flow damper in the spigot **PLSD-R**.

Manufacturer **MADEL**.

	0,5 < L < 1,2		1,3 < L < 1,5		1,6 < L < 2		N	E
	H	D1	H	D1	H	D1		
KIS 1	256	1/158	256	1/158	256	2/158	69	68
KIS 2	256	1/158	256	2/158	256	2/158	108	107

 KIS

m	KIS 1	Vmin m/s	Vmax m/s	Qmin m3/h	Qmax m3/h
0.5	0.0024	2.5	6.5	25	57
1	0.0048	2.5	6.5	43	112
1,1	0.0053	2.5	6.5	48	125
1,2	0.0058	2.5	6.5	52	135
1,3	0.0063	2.5	6.5	56	146
1,4	0.0067	2.5	6.5	60	158
1,5	0.0072	2.5	6.5	65	169
1,6	0.0077	2.5	6.5	69	180
1,7	0.0082	2.5	6.5	74	191
1,8	0.0087	2.5	6.5	78	203
1,9	0.0092	2.5	6.5	82	215
2	0.0096	2.5	6.5	86	225



m	KIS 2	Vmin m/s	Vmax m/s	Qmin m3/h	Qmax m3/h
0.5	0.0048	2.5	5.5	43	95
1	0.0096	2.5	5.5	86	190
1,1	0.0106	2.5	5.5	95	210
1,2	0.0116	2.5	5.5	104	229
1,3	0.0125	2.5	5.5	112	248
1,4	0.0135	2.5	5.5	122	267
1,5	0.0145	2.5	5.5	130	286
1,6	0.0154	2.5	5.5	139	305
1,7	0.0164	2.5	5.5	148	324
1,8	0.0174	2.5	5.5	157	343
1,9	0.0183	2.5	5.5	165	365
2	0.0193	2.5	7	174	382

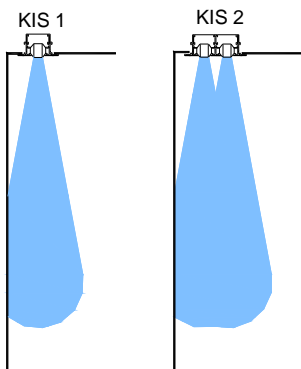
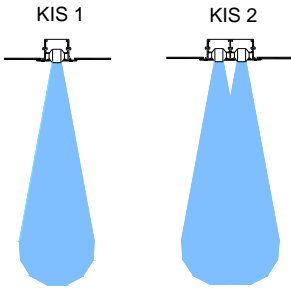

CORRECTION FACTOR FOR THROW KL

	0.5 m	1 m	1.5 m	2 m
1	0.71	1	1.07	1.14
2	0.73	1	1.09	1.15

$AL'02 = KI \times AL02$

FREE VELOCITY, PRESSURE LOSS AND SOUND POWER LEVEL, THROW WITH CEILING EFFECT: 1 DIRECTION.

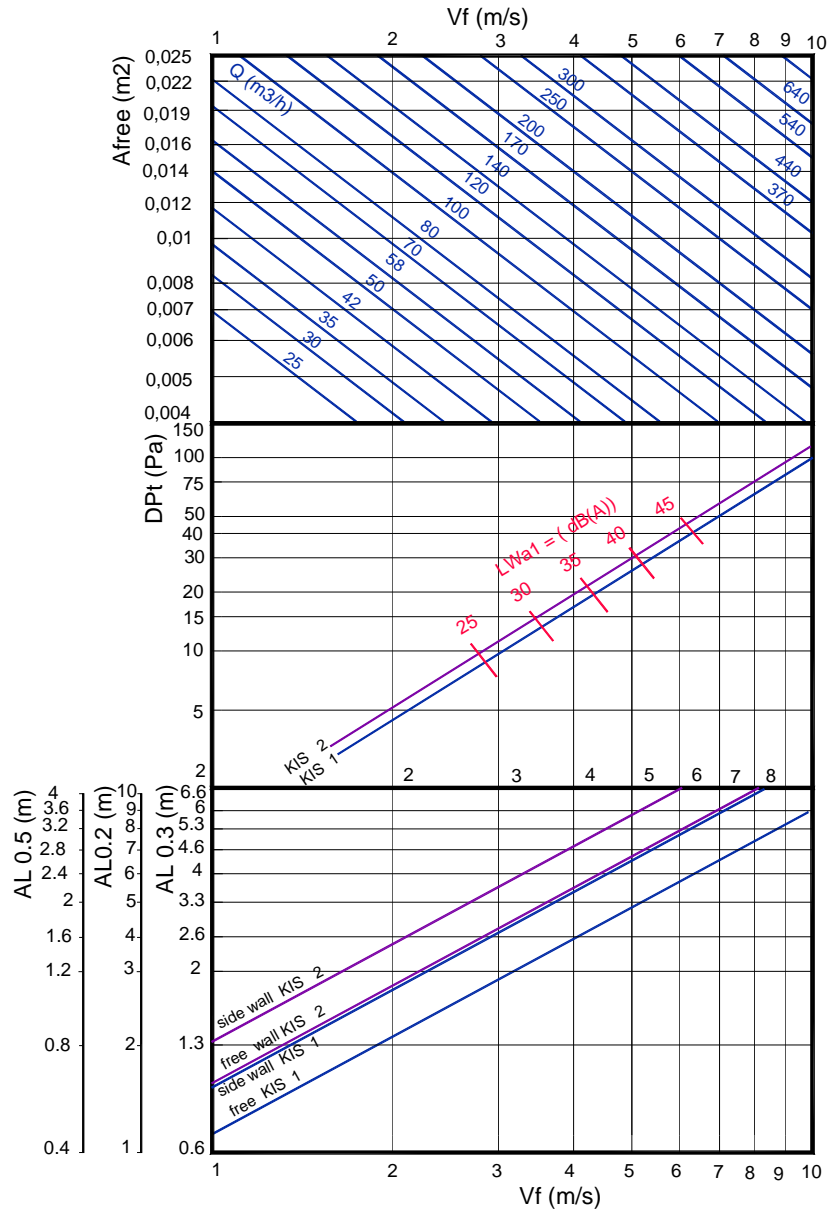

Note: In MadelMedia Octava band centre frequency in Hz.

CORRECTION FACTOR FOR DPt AND Lwa1.

	0.5 m			1 m			1.5 m			2 m			
	100%	50%	0%	100%	50%	0%	100%	50%	0%	100%	50%	0%	
1	Dpt	0.95	2.35	3.15	1	1.4	2.2	1	1.4	2.2	1.1	2.5	3.3
1	Lwa1	-6.1	-3.1	-3.6	0	+0.8	+0.4	+0.9	+1.6	+1	-2.1	-0.5	-1.9
2	Dpt	0.98	2.48	3.25	1	1.5	2.3	1	1.5	2.3	1.2	2.7	3.5
2	Lwa1	-3.8	-3.4	-2.9	0	+0.6	+0.6	+2.4	+3.3	+3.2	-0.3	+0.9	+1.1

$DPt1 = Kp \times DPt$

$Lwa1 = Lwa + Kf$

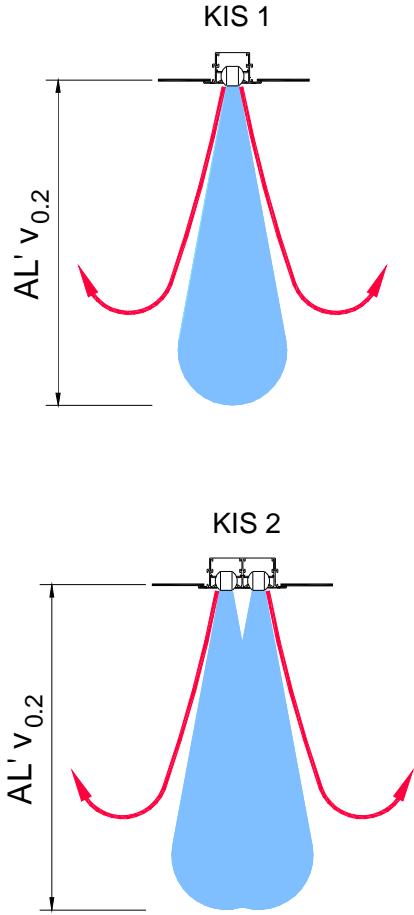

CORRECTION FACTOR FOR VERTICAL THROW ($ALv_{0.2}$) DT

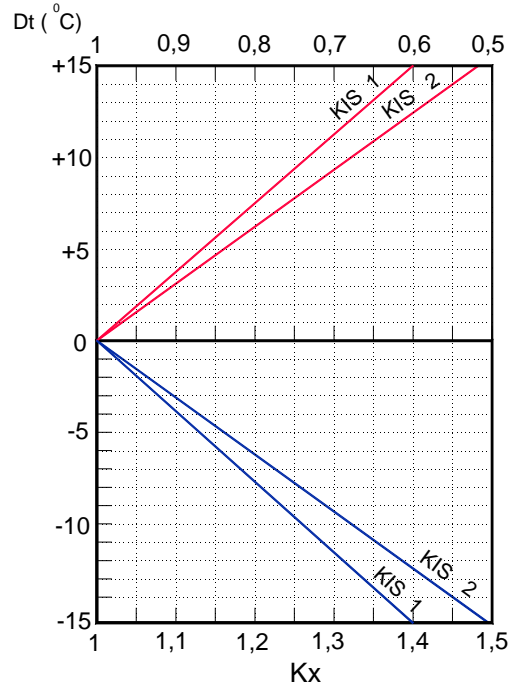

$$AL' v_{0.2} = Kx \times AL_{0.2}$$



KIS

m	KIS 1	Vmin	Vmax	Qmin	Qmax
		m/s	m/s	m3/h	m3/h
0.5	0.0024	2.5	6.5	25	57
1	0.0048	2.5	6.5	43	112
1,1	0.0053	2.5	6.5	48	125
1,2	0.0058	2.5	6.5	52	135
1,3	0.0063	2.5	6.5	56	146
1,4	0.0067	2.5	6.5	60	158
1,5	0.0072	2.5	6.5	65	169
1,6	0.0077	2.5	6.5	69	180
1,7	0.0082	2.5	6.5	74	191
1,8	0.0087	2.5	6.5	78	203
1,9	0.0092	2.5	6.5	82	215
2	0.0096	2.5	6.5	86	225



m	KIS 2	Vmin	Vmax	Qmin	Qmax
		m/s	m/s	m3/h	m3/h
0.5	0.0048	2.5	5.5	43	95
1	0.0096	2.5	5.5	86	190
1,1	0.0106	2.5	5.5	95	210
1,2	0.0116	2.5	5.5	104	229
1,3	0.0125	2.5	5.5	112	248
1,4	0.0135	2.5	5.5	122	267
1,5	0.0145	2.5	5.5	130	286
1,6	0.0154	2.5	5.5	139	305
1,7	0.0164	2.5	5.5	148	324
1,8	0.0174	2.5	5.5	157	343
1,9	0.0183	2.5	5.5	165	365
2	0.0193	2.5	7	174	382

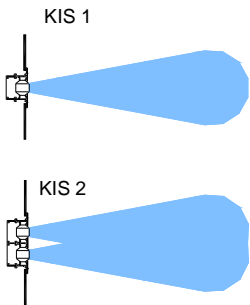
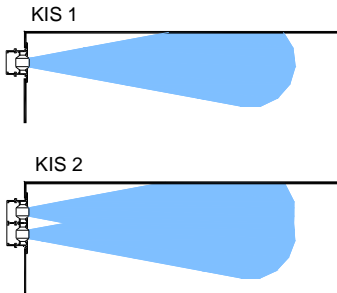

CORRECTION FACTOR FOR THROW KL

	0.5 m	1 m	1.5 m	2 m
1	0.71	1	1.07	1.14
2	0.73	1	1.09	1.15

$AL'02 = KI \times AL02$

FREE VELOCITY, PRESSURE LOSS AND SOUND POWER LEVEL, THROW WITH CEILING EFFECT: 1 DIRECTION.

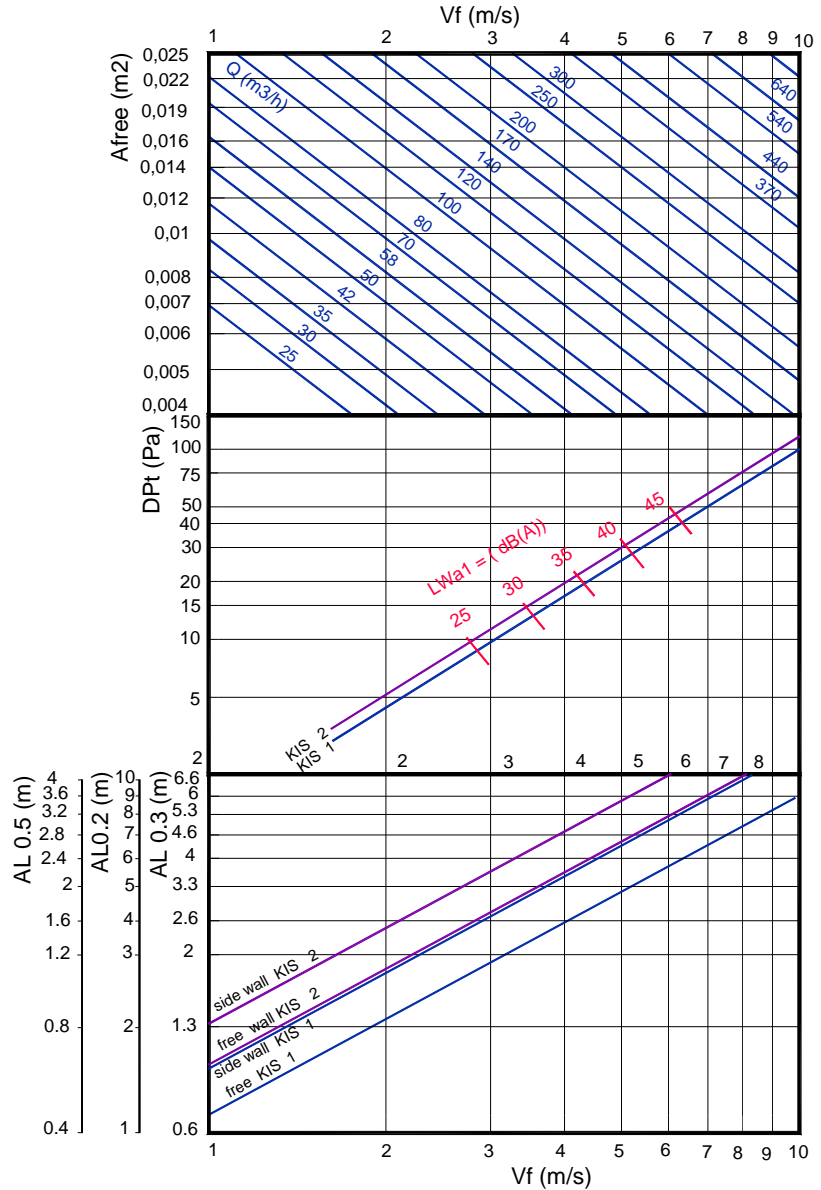

CORRECTION FACTOR FOR DPt AND Lwa1.

		0.5 m			1 m			1.5 m			2 m		
		100%	50%	0%	100%	50%	0%	100%	50%	0%	100%	50%	0%
1	Dpt	0.95	2.35	3.15	1	1.4	2.2	1	1.4	2.2	1.1	2.5	3.3
	Lwa1	-6	-3	-3,6	0	0,8	0,4	+1,2	+1,9	+1,4	-2	-	-1,6
2	Dpt	0.98	2.48	3.25	1	1.5	2.3	1	1.5	2.3	1.2	2.7	3.5
	Lwa1	-4	-3,6	-3,1	0	+0,6	+0,6	+2,3	+3,2	+3,1	0	+1	+1,2

$DPt1 = Kp \times DPt$

$Lwa1 = Lwa + Kf$

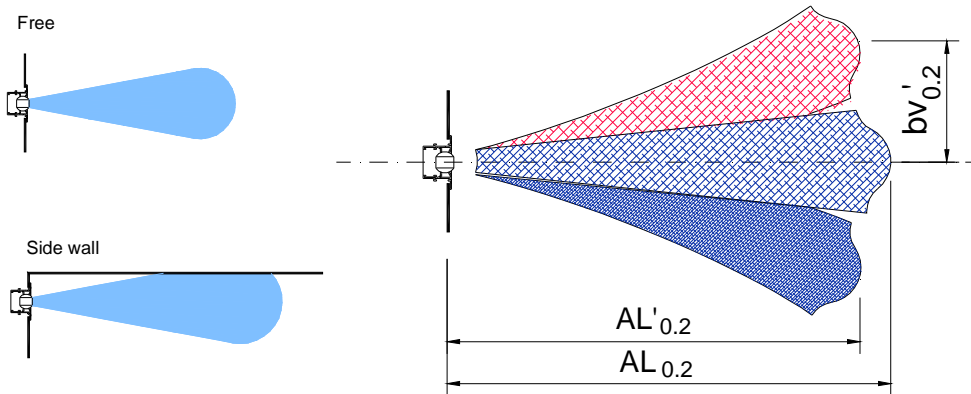

CORRECTION FACTOR FOR VERTICAL DIFFUSION (bv) FOR DT (-).

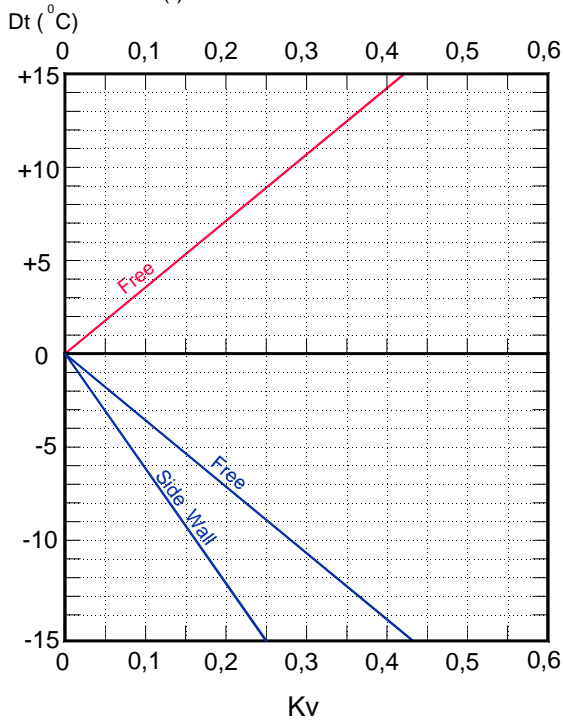

$$bv'_{0.2} = Kv \times Al_{0.2}$$

Kv = Correction factor for the vertical diffusion.

CORRECTION FACTOR FOR THROW (L0.2) DT (-).

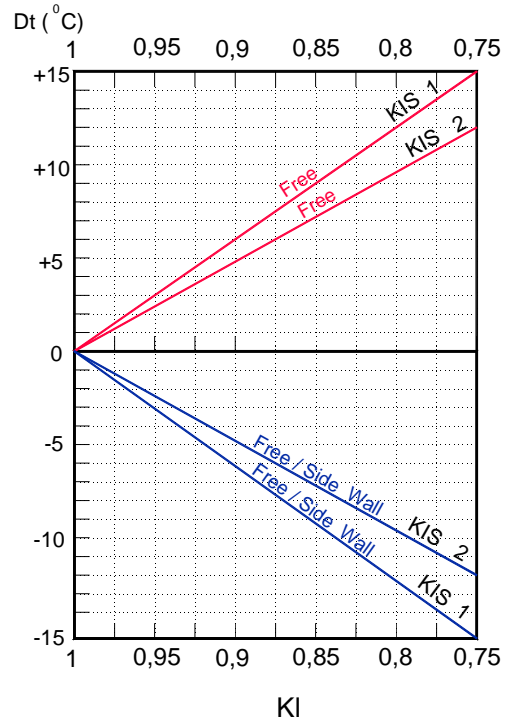

$$Al'_{0.2} = KI \times Al_{0.2}$$

KI = Correction factor for the throw.

 KIS

m	KIS 1	Vmin m/s	Vmax m/s	Qmin m3/h	Qmax m3/h
0.5	0.0024	2.5	6.5	25	57
1	0.0048	2.5	6.5	43	112
1,1	0.0053	2.5	6.5	48	125
1,2	0.0058	2.5	6.5	52	135
1,3	0.0063	2.5	6.5	56	146
1,4	0.0067	2.5	6.5	60	158
1,5	0.0072	2.5	6.5	65	169
1,6	0.0077	2.5	6.5	69	180
1,7	0.0082	2.5	6.5	74	191
1,8	0.0087	2.5	6.5	78	203
1,9	0.0092	2.5	6.5	82	215
2	0.0096	2.5	6.5	86	225



m	KIS 2	Vmin m/s	Vmax m/s	Qmin m3/h	Qmax m3/h
0.5	0.0048	2.5	5.5	43	95
1	0.0096	2.5	5.5	86	190
1,1	0.0106	2.5	5.5	95	210
1,2	0.0116	2.5	5.5	104	229
1,3	0.0125	2.5	5.5	112	248
1,4	0.0135	2.5	5.5	122	267
1,5	0.0145	2.5	5.5	130	286
1,6	0.0154	2.5	5.5	139	305
1,7	0.0164	2.5	5.5	148	324
1,8	0.0174	2.5	5.5	157	343
1,9	0.0183	2.5	5.5	165	365
2	0.0193	2.5	7	174	382

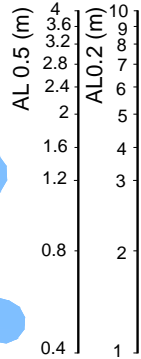
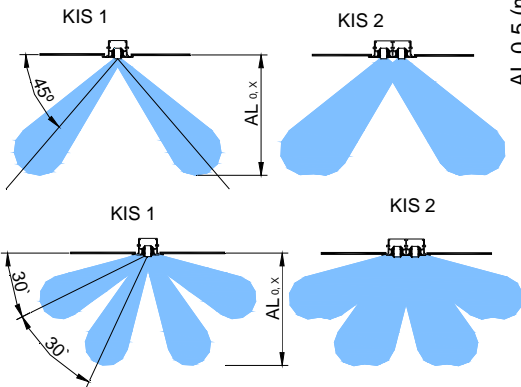

FREE VELOCITY, PRESSURE LOSS AND SOUND POWER LEVEL, THROW WITH CEILING EFFECT: 1 DIRECTION.

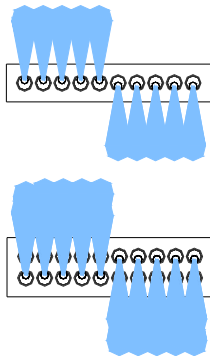
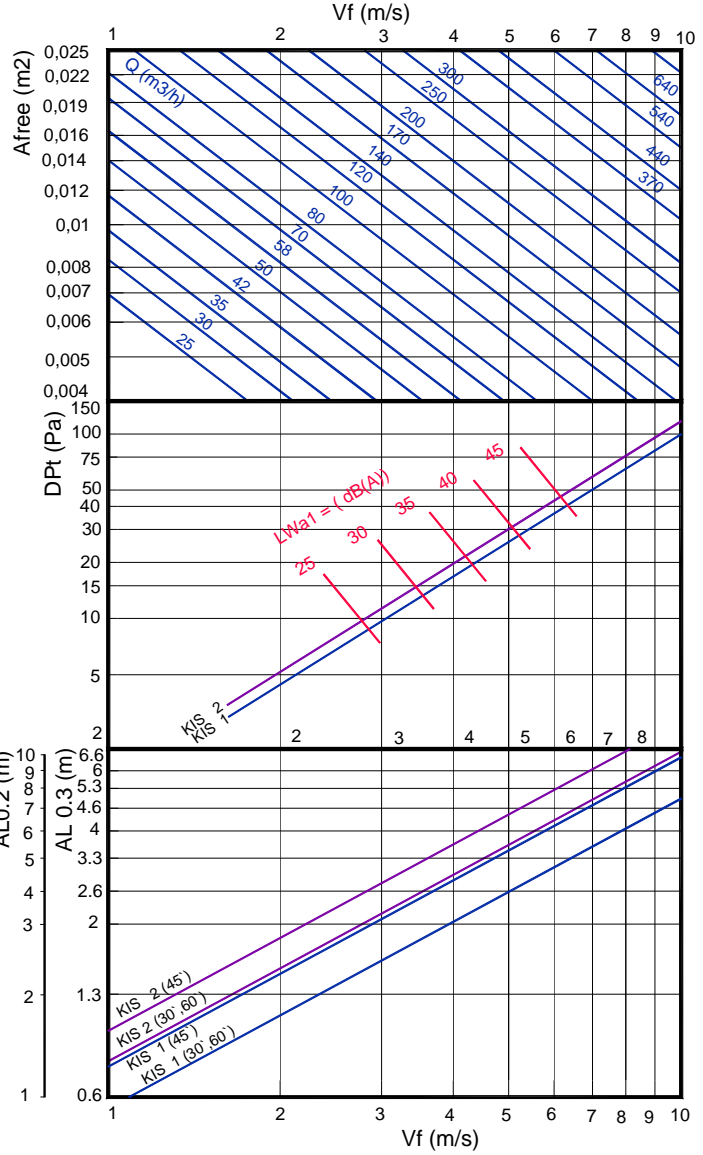

CORRECTION FACTOR FOR THROW KL

	0.5 m	1 m	1.5 m	2 m
1	0.71	1	1.07	1.14
2	0.73	1	1.09	1.15

$AL'02 = KI \times AL02$

CORRECTION FACTOR FOR DPT AND Lwa1.

	0.5 m			1 m			1.5 m			2 m		
	100%	50%	0%	100%	50%	0%	100%	50%	0%	100%	50%	0%
1 Dpt	0.95	2.35	3.15	1	1.4	2.2	1	1.4	2.2	1.1	2.5	3.3
1 Lwa1	-6	-3	-3.7	0	+0.8	+0.4	+1	+1.7	+1.2	-2.1	-0.4	-1.9
2 Dpt	0.98	2.48	3.25	1	1.5	2.3	1	1.5	2.3	1.2	2.7	3.5
2 Lwa1	-3.7	-3.4	-2.9	0	+0.6	+0.6	+2.4	+3.3	+3.2	-0.5	+0.8	+0.9

$Dpt1 = Kp \times Dpt$
 $Lwa1 = Lwa + Kf$

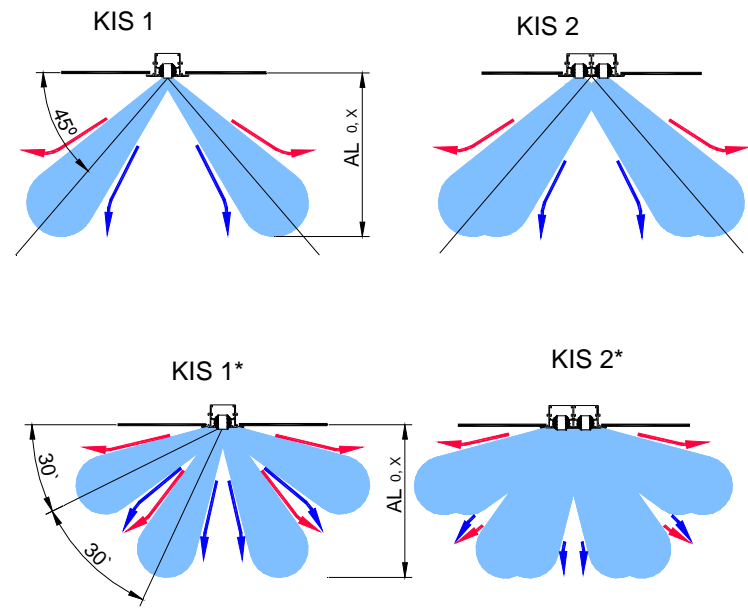

CORRECTION FACTOR FOR VERTICAL THROW ($AV_{0,2}$) DT

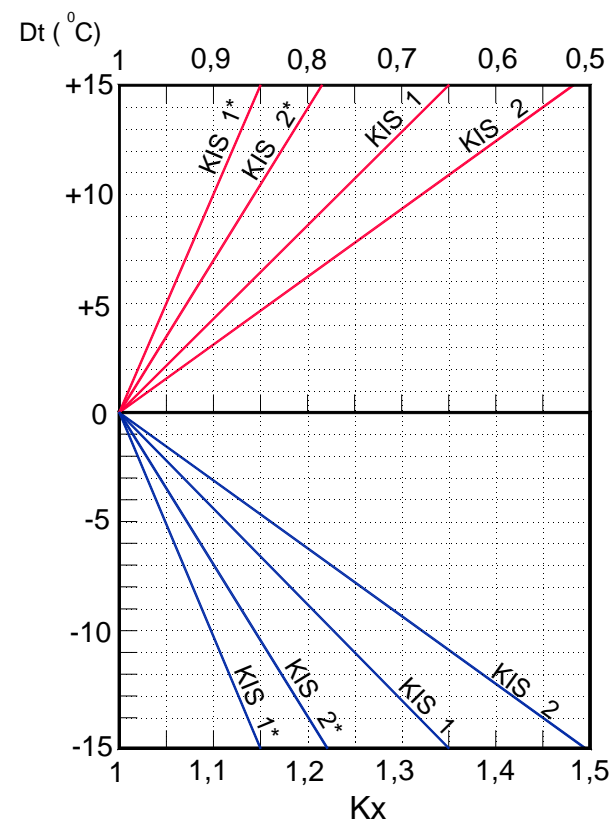

$$AL' v_{0,2} = K_x \times AL_{0,2}$$