

LOOK hidden linear diffusers



MADEL®

The **LOOK** hidden linear diffusers are designed to combine the aesthetics with the technical performance. They can be mounted in false ceilings hiding the frame with filler and leaving visible only the slot.

They allow the formation of diffuser continuous lines, with active and inactive areas, without breaking the uniformity of the whole.

They are suitable both for supply and return. By adjusting their blade it is possible to obtain a horizontal distribution of the air in one or the other direction or its vertical projection without change the volume of air.

The **LOOK** diffusers admit a flow variation of 60 % keeping the air stream stable.

These diffusers can be used from 2.6 up to 4 meters high and at a temperature differential up to 12° C.

LOOK-CM

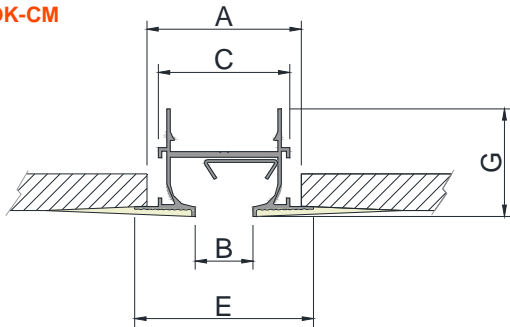

LOOK	A	B	C	G	E
20	55	20	47	38,2	63,5
30	84	30	76	45,2	97,3
40	94	40	86	45,2	107,3

LOOK-SM

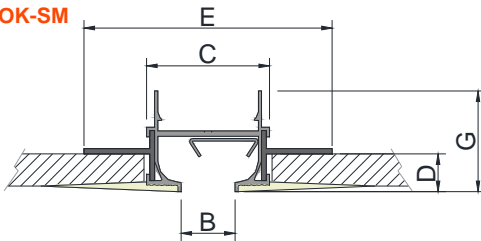

LOOK	B	C	D	G	E
20	20	47	14	38,2	94,3
30	30	76	14	45,2	123,5
40	40	86	14	45,2	133,5

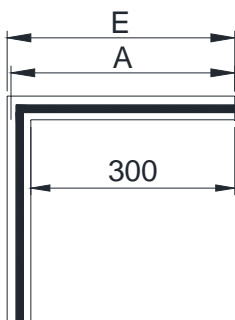
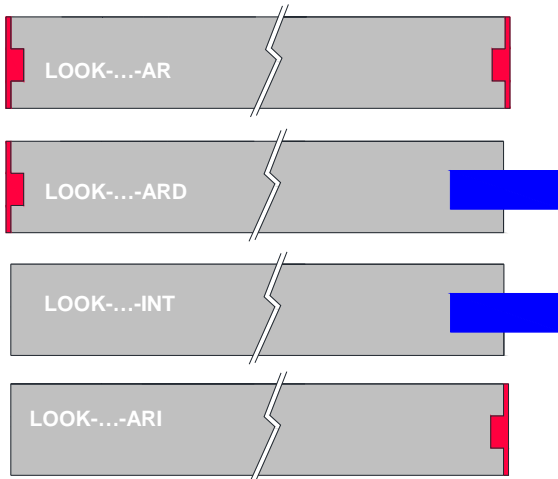

A90/LOOK

LOOK	E	A
20	364	359
30	397	391
40	407	401

CLASSIFICATION

LOOK-CM Diffuser with large frame.

LOOK-SM Diffuser with short frame.

...AR Diffuser suitable for lengths ≤ 2 m.

...-ARI / ARD Diffuser with an end border on the left or right side, required to form lines > 2 m.

...INT Diffuser without end borders, requires to form lines > 4 m.

MATERIAL

Diffuser constructed from aluminium and vane from galvanised steel.

ACCESSORIES

A90/LOOK-20...40 Inactive diffuser making a 90° angle.

LOOK-CM (D) + PLOK-CM...-R

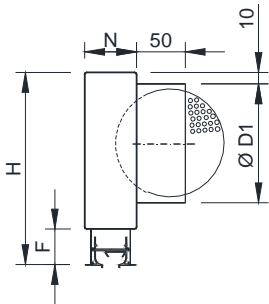

LOOK-CM (PM) + PLOK-CM...-R

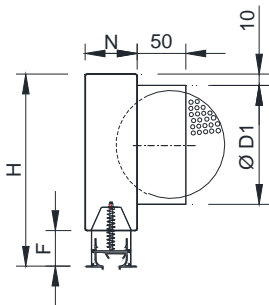

LOOK-SM (D) + PLOK-SM...-R

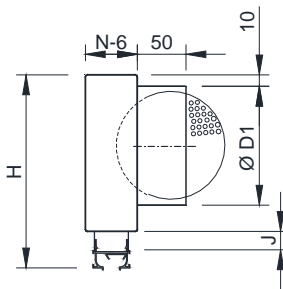

LOOK-SM (L) + PLOK-SM...-R

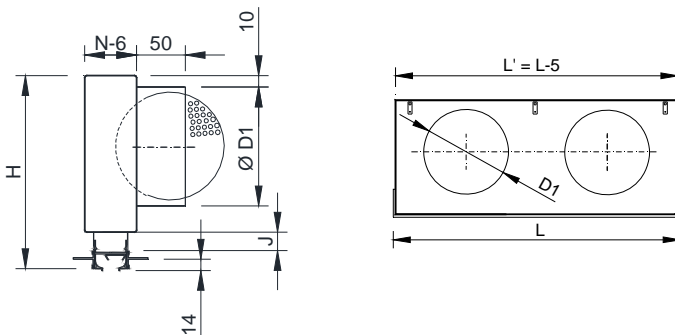

ACCESSORIES

PLOK-CM Plenum box with lateral connection for LOOK-CM. It includes supports to hang from the ceiling. Made in galvanised steel.

PLOK-SM Plenum box with lateral connection for LOOK-SM. It includes supports to hang from the ceiling. Made in galvanised steel. Plenum box always riveted to the diffuser.

...-R Plenum box with a flow damper in the spigot.

.../AIS/ Plenum box thermo acoustically insulated by a foam with a coefficient of thermal conductivity of 0,04 w/mk. This foam complies with the fire reaction specifications:

- UNE 23-727 M2
- NFP 92-501 M2
- DIN 4102 M2

Look	L ≤ 0,5		L ≤ 1		L ≤ 1,2		L ≤ 1,5		L ≤ 2		N	F	J
	H	D1	H	D1	H	D1	H	D1	H	D1			
20	256	1/158	256	1/158	256	1/158	256	1/158	256	2/158	69	36	14,3
30	256	1/158	256	1/158	256	1/158	256	1/158	256	2/158	98	42	20,3
40	256	1/158	296	1/198	296	1/198	296	2/198	296	2/198	108	42	20,3

LOOK-CM (PM)

Patented

1.- Remove deflector

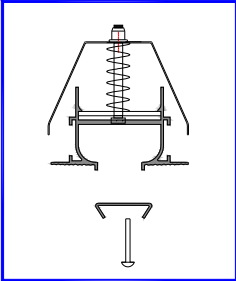

2.- Adjust crossbar

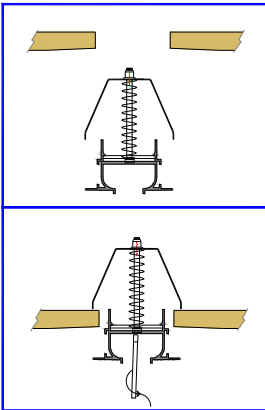

3.- Put deflector

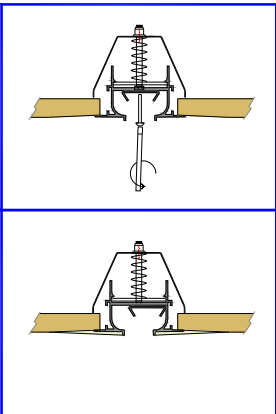

4.-Protect with anti-cracks tape and cover with filler the frame



LOOK-SM (L)

1.- Adjust and screw L

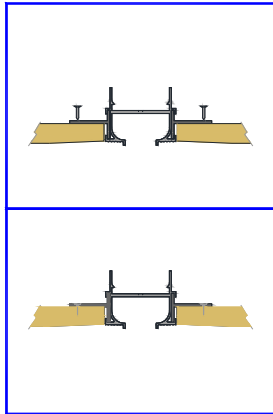

2.- Put deflector

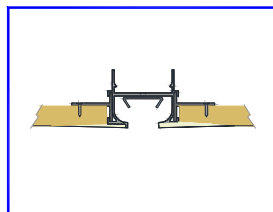

FIXING SYSTEMS

(D) Support brackets to hang the diffuser LOOK-... from the ceiling or the diffuser riveted to the plenum box LOOK-...+PLOK-...

(PM) Set of crossbars for installation of LOOK-CM in the false ceiling or for mounting into a plenum box PLOK-CM.

(L) Support brackets to hang the diffuser LOOK-SM from the ceiling or the diffuser riveted to the plenum LOOK-SM+PLOK-SM.

FINISHES

R9005 Painted in black RAL 9005.

M9016 Painted in white similar to RAL 9016.

R9010 Painted in white RAL 9010.

RAL... Painted in other RAL colours.

SPECIFICATION TEXT

Supply and mounting of hidden linear slot diffuser with directional vane, series **LOOK-CM-AR +PLOKCM-R R9005 20x1000 (D)** constructed from aluminium and steel, paint in black **RAL 9005**. With lateral circular connection plenum box and air flow damper in the spigot **PLOK-CM-R**. Manufacturer **MADEL**.

LOOK

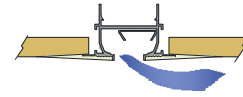

RECOMMENDED VELOCITY.

LOOK	Vmin (m/s)	Vmax (m/s)
20	2.5	4.5
30	2.5	4.5
40	2.5	4.5

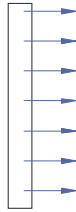

FREE VELOCITY, PRESSURE LOSS AND SOUND POWER LEVEL, THROW WITH CEILING EFFECT: 1 DIRECTION.

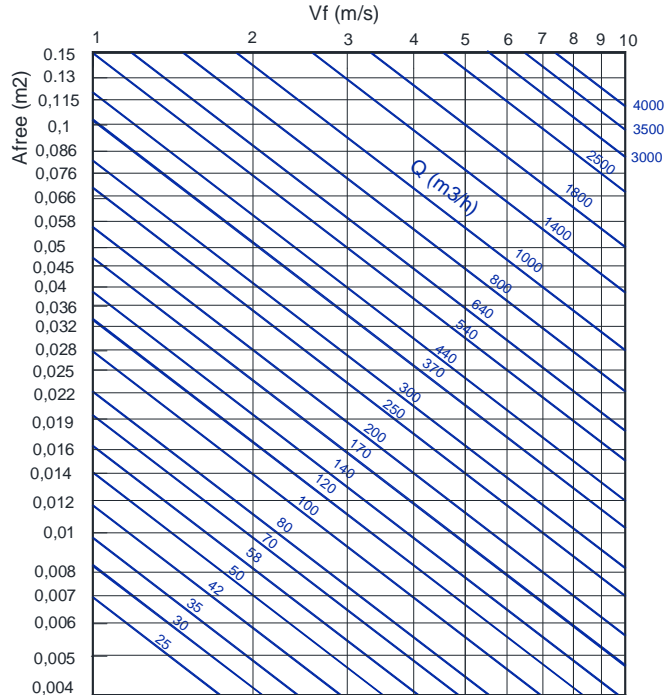

FREE FACE AREA (m^2).

	0.5 m	1 m	1.2 m	1.5 m	1.8 m	2 m
20	0.0067	0.0135	0.0162	0.0202	0.0243	0.0270
30	0.0099	0.0199	0.0239	0.0299	0.0358	0.0398
40	0.0112	0.0223	0.0268	0.0334	0.0401	0.0446

CORRECTION FACTOR FOR DPT AND Lwa1.

		0.5 m < x < 0.7 m			0.8 m < x < 1.2 m			1.3 m < x < 1.7 m			1.8 m < x < 2 m		
		100%	50%	25%	100%	50%	25%	100%	50%	25%	100%	50%	25%
20	Dpt	0.88	2.88	3	1	1.4	2.2	1.3	2.7	3.5	1.5	2.9	3.7
	Lwa1	-	-3	-5	-	4	7	-	3	5	-	3	7
30	Dpt	0.93	2.68	3.12	1	1.45	2.25	1	2.1	2.9	1.35	2.8	3.6
	Lwa1	-	-3.3	-4	-	2.3	3.8	2.2	3.1	4.1	0	2	4.1
40	Dpt	0.98	2.48	3.25	1	1.5	2.3	1	1.5	2.3	1.2	2.7	3.5
	Lwa1	-	-3.6	-3.1	-	0.6	0.6	2.3	3.2	3.1	0	1	1.2

$Dpt1 = K_p \times Dpt$

$Lwa1 = Lwa + K_f$

CORRECTION FACTOR FOR THROW KL

LOOK	0.5 m	1 m	1.2 m	1.5 m	1.8 m	2 m
20	0.8	1	1.13	1.27	1.35	1.43
30	0.76	1	1.09	1.18	1.23	1.29
40	0.73	1	1.05	1.09	1.12	1.15

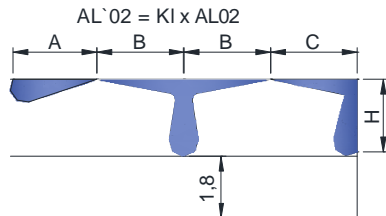

$AL_{0.2} = A$
 $AL_{0.2} = B + H$
 $AL_{0.2} = C + H$

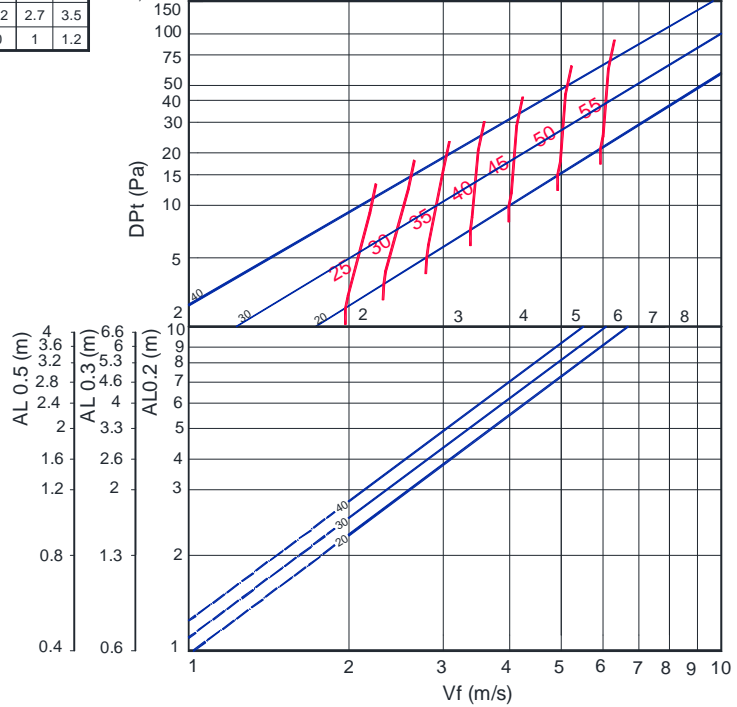

LOOK

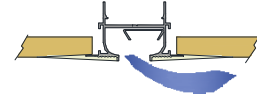

CORRECTION FACTOR FOR VERTICAL DIFFUSION (bv) FOR DT (-).

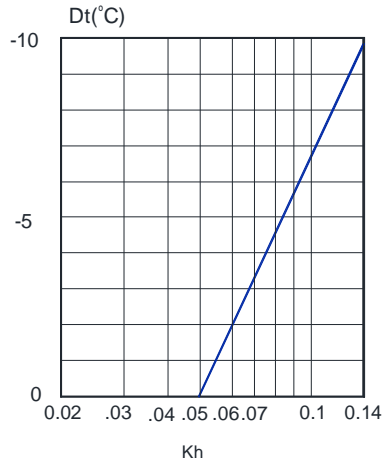

Kh = Correction factor for the vertical diffusion.

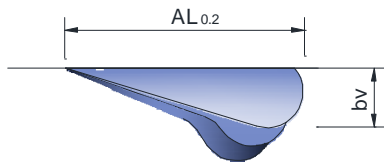

CORRECTION FACTOR FOR THROW (L0.2) DT (-).

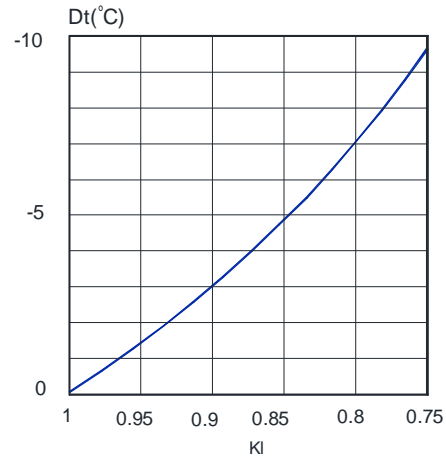

KI = Correction factor for the throw.

$$bv = Kh \times Al \quad 0.2$$

$$AL'_{0.2} (Dt < 0) = KI \times AL_{0.2}$$

TEMPERATURE RATIO.

$$\frac{Dtl}{Dtz} = \frac{t_{room} - t_x}{t_{room} - t_{supply}}$$

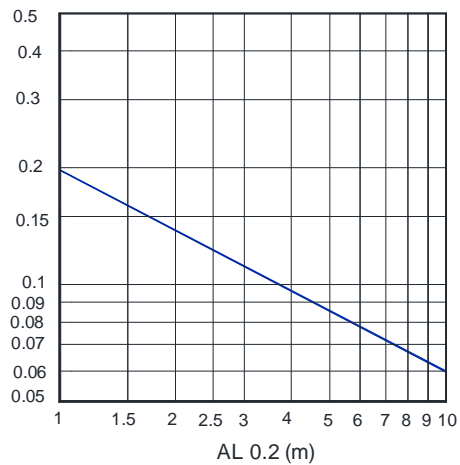

INDUCTION RATIO.

$$i = \frac{Q_r}{Q_0} = \frac{Q \text{ total in } x}{Q \text{ supply}}$$

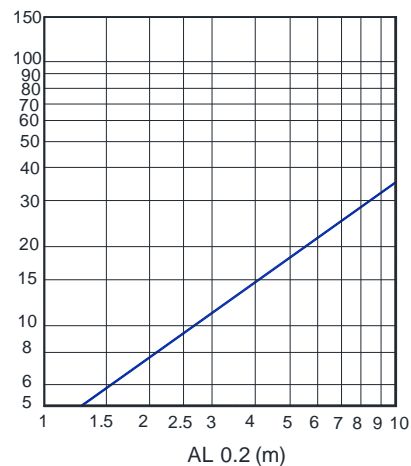

LOOK

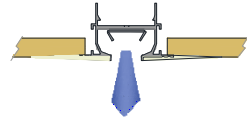

RECOMMENDED VELOCITY:

LOOK	Vmin (m/s)	Vmax (m/s)
20	2.5	4.5
30	2.5	4.5
40	2.5	4.5

FREE VELOCITY, PRESSURE LOSS AND SOUND POWER LEVEL:
VERTICAL SUPPLY.

FREE FACE AREA (m²).

LOOK	0.5 m	1 m	1.2 m	1.5 m	1.8 m	2 m
20	0.0067	0.0135	0.0162	0.0202	0.0243	0.0270
30	0.0099	0.0199	0.0239	0.0299	0.0358	0.0398
40	0.0112	0.0223	0.0268	0.0334	0.0401	0.0446

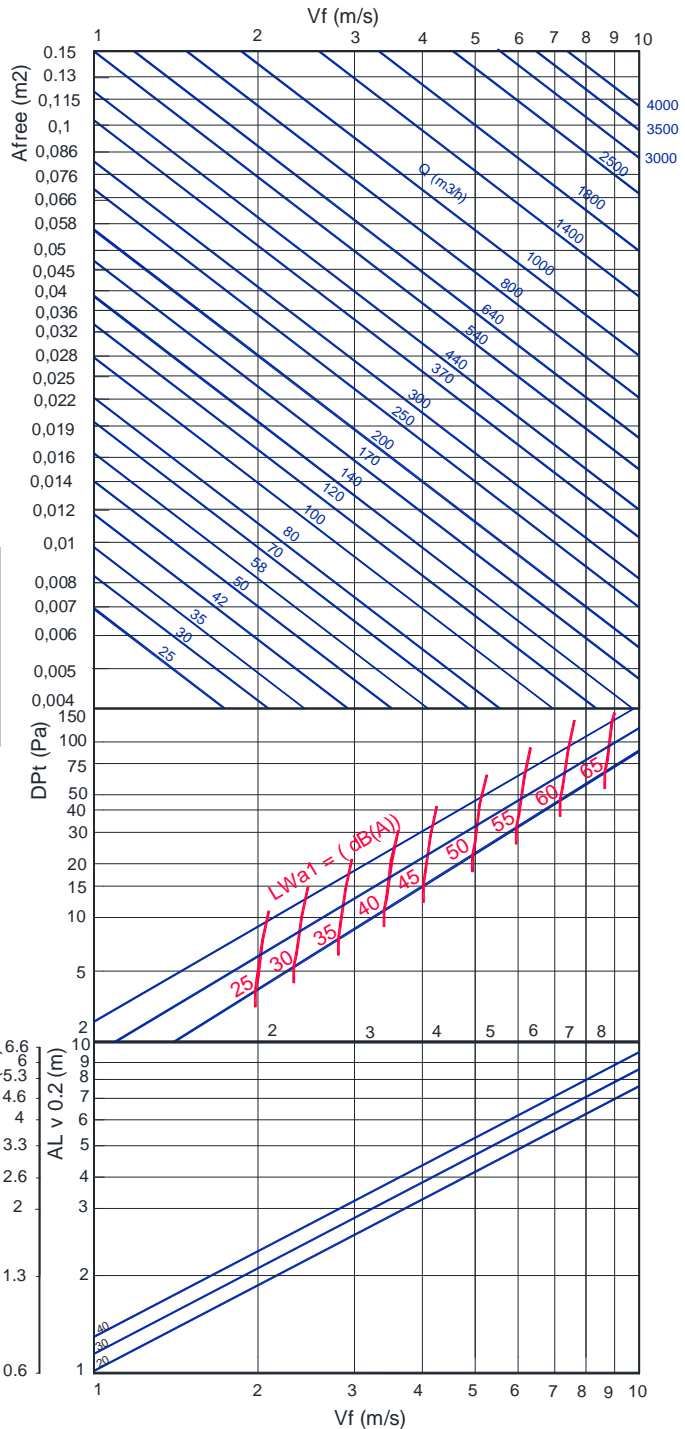

CORRECTION FACTOR FOR Dpt AND Lwa1.

		0.5 m < x < 0.7 m			0.8 m < x < 1.2 m			1.3 m < x < 1.7 m			1.8 m < x < 2 m		
		100%	50%	25%	100%	50%	25%	100%	50%	25%	100%	50%	25%
20	Dpt	0.88	2.88	3	1	1.4	2.2	1.3	2.7	3.5	1.5	2.9	3.7
	Lwa1	-	-3	-5	-	4	7	-	3	5	-	3	7
30	Dpt	0.93	2.68	3.12	1	1.5	2.3	1	2.1	2.9	1.3	2.8	3.6
	Lwa1	-	-3.2	-4	-	2.3	3.8	-	3.2	4.1	-	2	4
40	Dpt	0.98	2.48	3.25	1	1.5	2.3	1	1.5	2.3	1.2	2.7	3.5
	Lwa1	-	-3.4	-2.9	-	0.6	0.6	-	3.3	3.2	-	0.9	1.1

$$Dpt1 = Kp \times Dpt$$

$$Lwa1 = Lwa + Kf$$

CORRECTION FACTOR FOR
THROW KL

LOOK	0.5 m	1 m	1.2 m	1.5 m	1.8 m	2 m
20	0.7	1	1.02	1.04	1.07	1.1
30	0.72	1	1.03	1.07	1.08	1.1
40	0.73	1	1.04	1.09	1.1	1.15

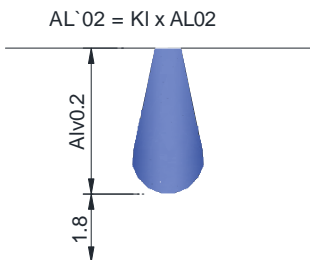

LOOK

CORRECTION FACTOR FOR VERTICAL THROW (Alv0,2) DT(+).

LOOK	DT (+5)	DT (+10)
20	0.75	0.64
30	0.76	0.65
40	0.76	0.65

$DT = T_{\text{supply}} - T_{\text{room}}$

$Alv_{0,2} (DT +) = K_v \times Al_{02}$

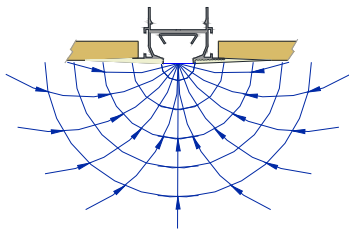

RECOMMENDED VELOCITY.

LOOK	Vmin (m/s)	Vmax (m/s)
20	2.5	3.5
30	2.5	3.5
40	2.5	3.5

FREE FACE AREA (m2).

	0.5 m	1 m	1.2 m	1.5 m	1.8 m	2 m
20	0.0067	0.0135	0.0162	0.0202	0.0243	0.0270
30	0.0099	0.0199	0.0239	0.0299	0.0358	0.0398
40	0.0112	0.0223	0.0268	0.0334	0.0401	0.0446

CORRECTION FACTOR FOR DPt AND Lwa1.

		0.5 m < x < 0.7 m		0.8 m < x < 1.2 m		1.3 m < x < 1.7 m		1.8 m < x < 2 m					
		100%	50%	25%	100%	50%	25%	100%	50%	25%			
20	Dpt	0.88	2.88	3	1	1.4	2.2	1.3	2.7	3.5	1.5	2.9	3.7
	Lwa1	-	3	5	-	4	7	-	3	5	-	3	7
30	Dpt	0.86	2.61	3.08	1	1.5	2.3	1.4	2.8	3.6	1.58	3.03	3.83
	Lwa1	-	3	5	-	4	7	-	4	7	-	3	8
40	Dpt	0.85	2.35	3.15	1	1.5	2.3	1.4	2.9	3.7	1.66	3.16	3.96
	Lwa1	-	3	5	-	4	7	-	4	7	-	3	8

$DPt1 = K_p \times DPt$

$Lwa1 = Lwa + K_f$

FREE VELOCITY, PRESSURE LOSS AND SOUND POWER LEVEL.

